

Intelli Vari-Focal Series











2094/252CE2

2 Megapixel IP Dome Camera
Motorized Varifocal Lens



Features :

- Resolution: 2MP (1920 × 1080).
- 2.8-12mm Motorized Vari-focal Lens.
- ICR auto switch, true day / night vision.
- 3D DNR, WDR, HLC, BLC, smart IR.
- H.265+, H.264+ compression.
- Supports PoE - IEEE802.3af.
- Built-in SD Card Slot supports up-to 256gb.
- Reset Button & local 12Vdc input / output option.
- Vandal Resistant metal casing.
- IP67 Ingress Protection - fully protected against dust and water.
- Support Tripple stream.
- Supports remote monitoring through professional UVSpro Video management Software (VMS).
- Support remote monitoring by smart phones & Tablet for Android & iOS application - iUVS.
- Supports Onvif profile for 3rd party integration.
- STQC Approved, BIS ER Certified.

 Vari-focal Lens	 WDR	 HLC
 AI Analytics	 BLC	 Light Explorer
 Defog / Video Mask & Tamper	 H.265+	 SD CARD SLOT
 PoE	 IP67	 day & Night



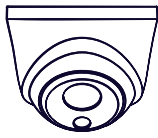

2094/252CE2

2 Megapixel IP Dome Camera Motorized Varifocal Lens



Specifications

Model	2094/252CE2
Imaging Sensor	1/2.7" Progressive CMOS
Effective Pixels	2MP 1920(H)×1080(V)
Min. Illumination	Color 0.004lux @ F1.2(AGC ON) ; B/W 0 lux @ IR ON
Lens Type	Motorized Varifocal : 2.8 - 12 mm
Field of View FOV	H :102.4° to 31.2°, V:54.4° to 17.5°, D:121.8° to 35.7°
DORI	D:(45 to 142)m,O:(18 to 56)m,R:(10 to 30)m,l:(5 to 15)m
Viewable Length IR	Maximum Up to 60m, Ideal 50m
Backlight Compensation	Off / On (5 Zone)
Motion Detection	Off/On (8 Level)
Wide Dynamic Range	DWDR
Digital Noise Reduction	3D DNR
Day & Night	IR cut filter with auto switch (Day /Night / Image / Schedule)
White Balance	Auto / Manual
Electronic Shutter Speed	1/5 ~ 1/20000s
On-Board Storage	Micro SD slot, up to 256GB
Alarm	1 input / 1 output
Audio	1 input , 1 output
Hardware Reset	Yes
Smart Feature	Face Recognition, Pedestrian & Vehicle , Intrusion , Line Crossing , Object Detection, Crossing Counting, Heat Map, Crowd Density, Queue Length , Rare Sound, Intrusion, Region Entrance, Region Exiting
Smart Alarm	Defog, Video Mask (TAMPER), SD card full, SD card error
General Function	Watermark, IP address filtering, video mask, heartbeat, illegal login lock
Ethernet	RJ45(10/100BASE-T)
Video Compression Format	H.265 / H.264 / H.265+ / H.264+
Stream Resolution	Main Stream : (1920 x 1080), (1280 x 960), (1280 x 720) Sub Stream : (1280 x 720), (640 x 480), (320 x 240) Third Stream : (640 x 480), (320 x 240)
Video Quality Adjustment	256Kbps ~ 8Mbps
Bitrate control method	CBR/VBR
IP	Ipv4
Protocol	TCP/IP,HTTP,DHCP,DNS,DDNS,RTP/RTSP, SMTP,NTP,HTTPS,FTP
Application Programming Interface	ONVIF (Profile S/G/T/M)
Operating Conditions	-35°~ +60°C / less than 90% RH
Ingress Protection & Tamper	IP67 & IK10
Input Voltage / Current	POE(IEEE802.3af) / D12V
Power Consumption	6W
Material	Metal

- Product Manufactured and Made in India
- The manufacturer reserves the right to change product features to deliver technical improvements or comply with new regulations.
- Urmet is a registered trademark of Urmet S.p.A., Via Bologna, 188/C - 10154, Torino, Italy

AI - 3rd GENERATION

- Face detection
- Heat Map / Crowd Density Detection / Queue length detection
- Object Abandon / Object Lost
- Human / Vehicle Classification
- Tripwire / Perimeter / Line Crossing / Loitering / Intrusion / Region Entrance & Exit
- Rare Sound Detection
- Video Tampering

DIMENSIONS

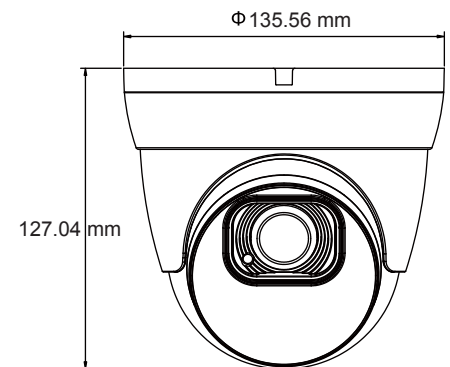

Video Management Software

iUVS pro



App



Manufactured & Marketed By:
Alba Urmet Communication And Security Private Limited

285 & 275, Udyog Vihar - IV, Gurgaon - 122001, Haryana, India

www.albaurmet.com

M : sales@albaurmet.com ; T : +91-9625-510-510

ALBA urmet
Security . IOT . Technology .